

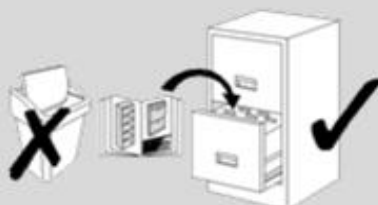

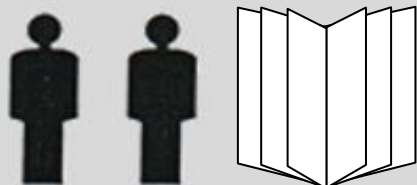

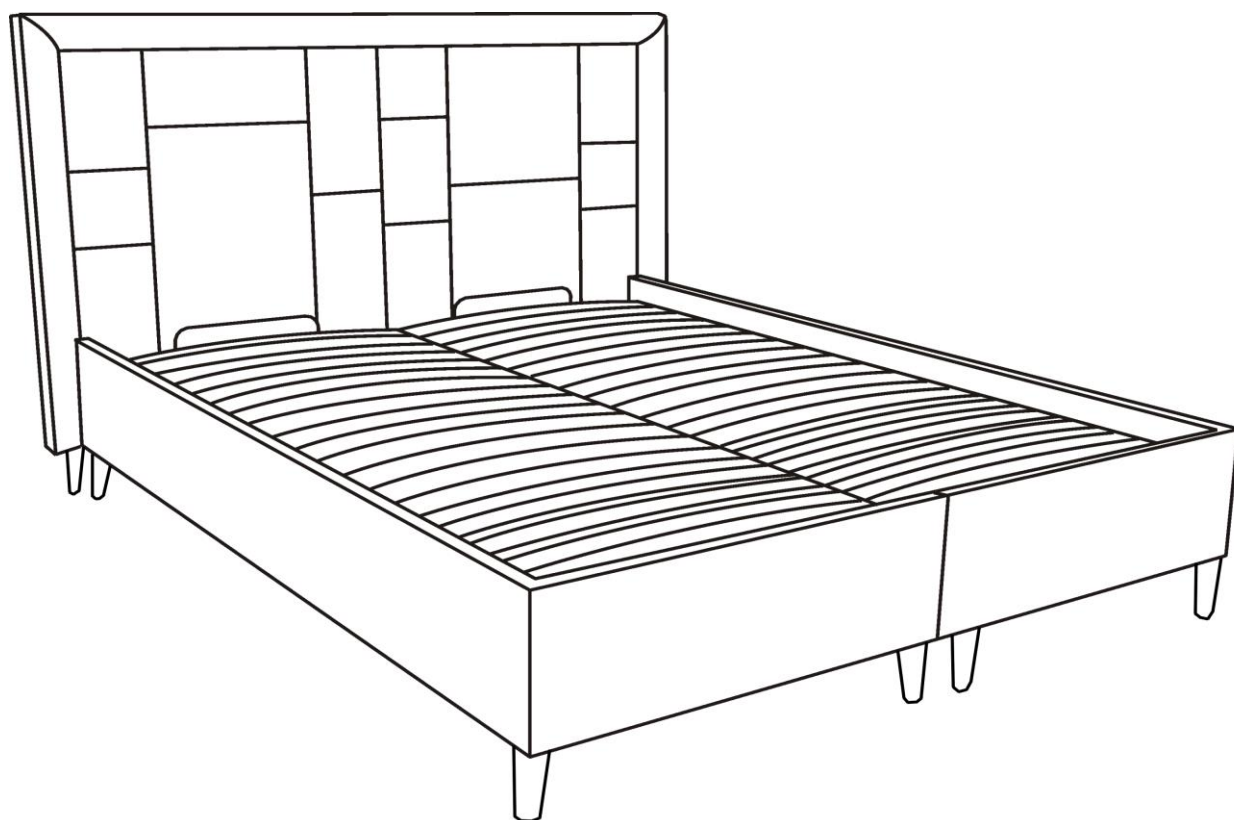







# KUGA.high LSBK140

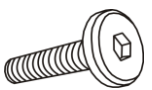
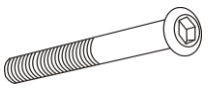

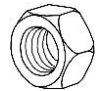
 <b>A</b> x4	 <b>B</b> x4	 <b>C</b> x4	 <b>D</b> x4	 <b>E</b> x1	 <b>F</b> x5	 <b>G</b> x3
 <b>H</b> x5	 <b>I</b> x5	 <b>J</b> x1	 <b>K</b> x8	 <b>L</b> x6		

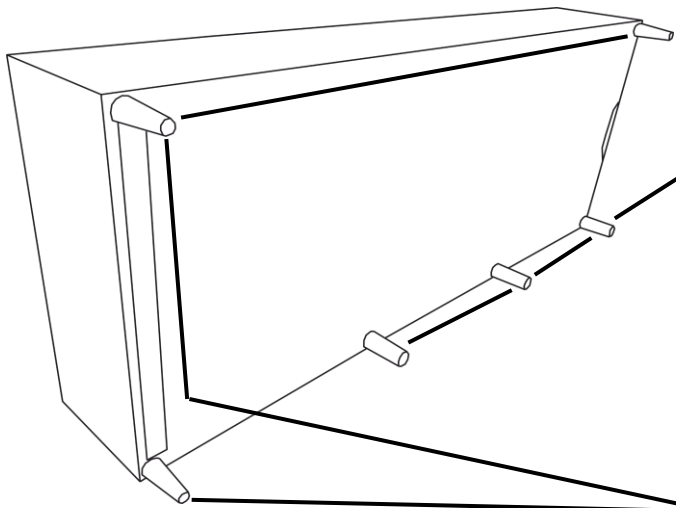

**1**

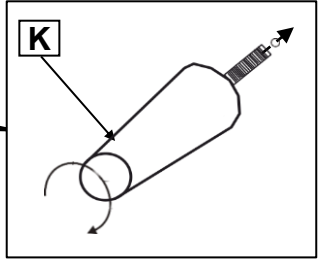
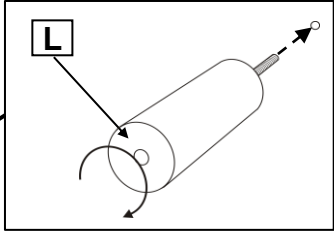

**x2**

**2**

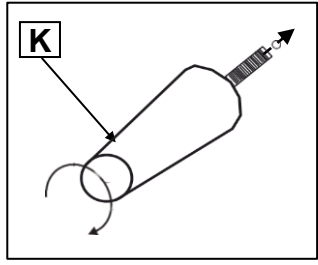
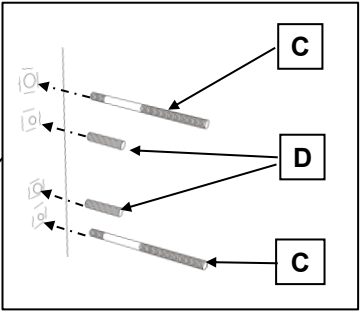
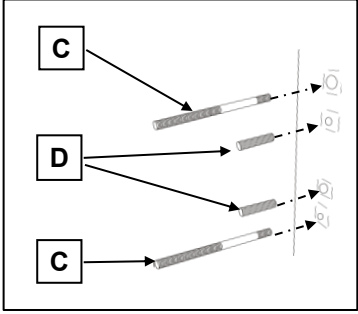
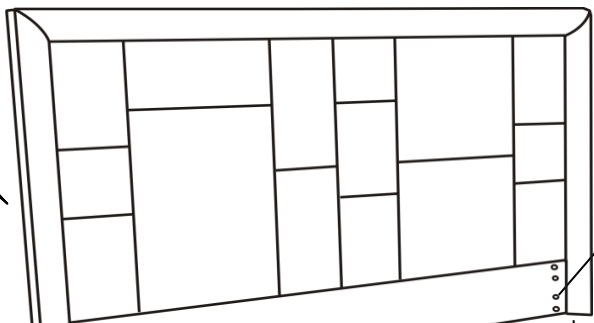

3

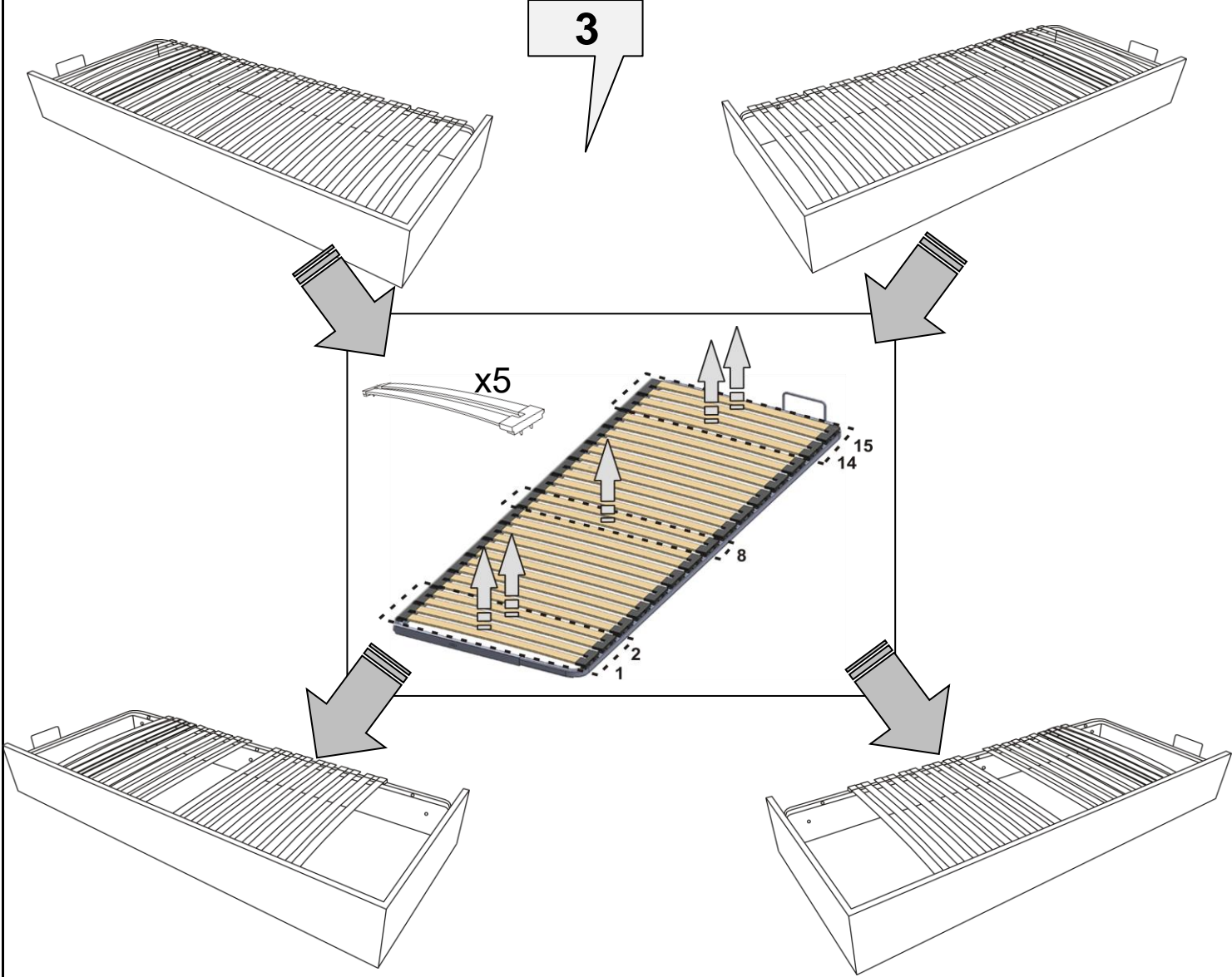

4

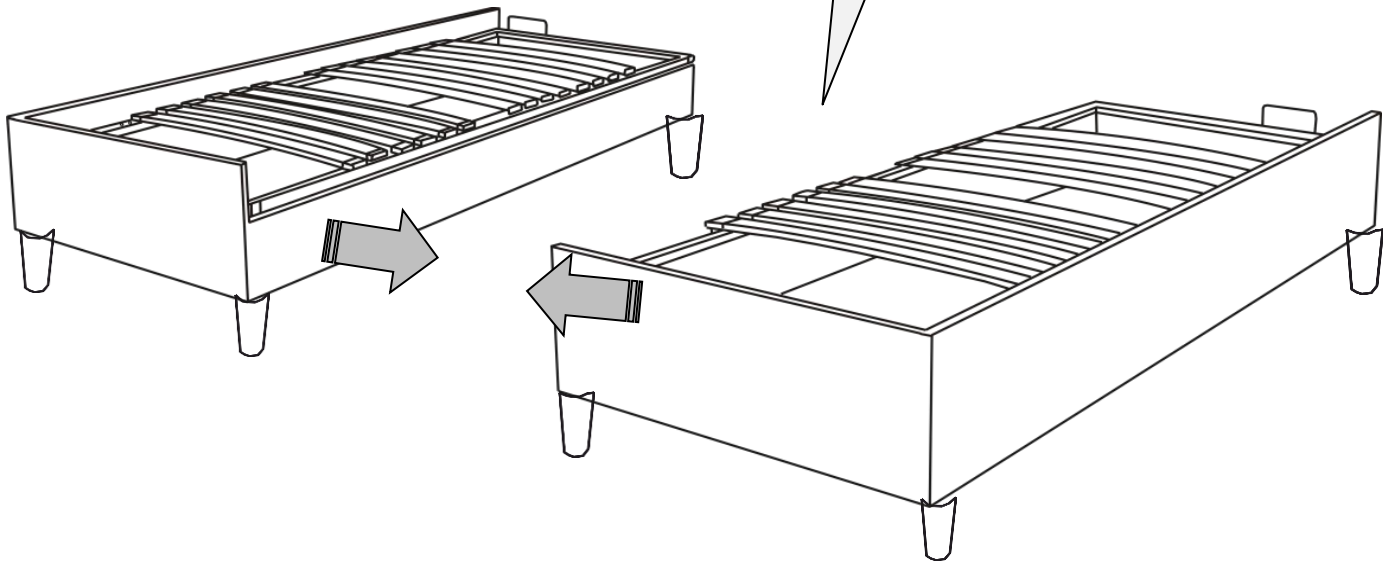

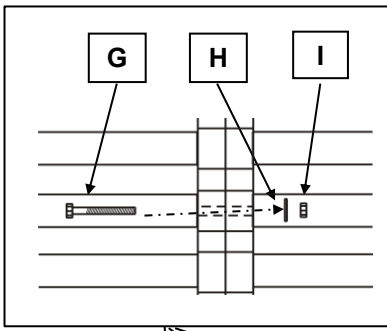

5

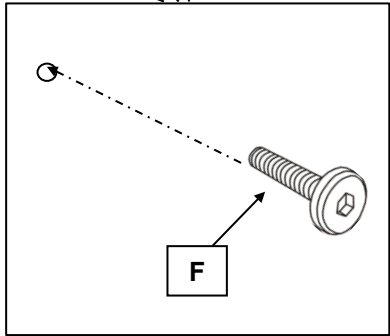
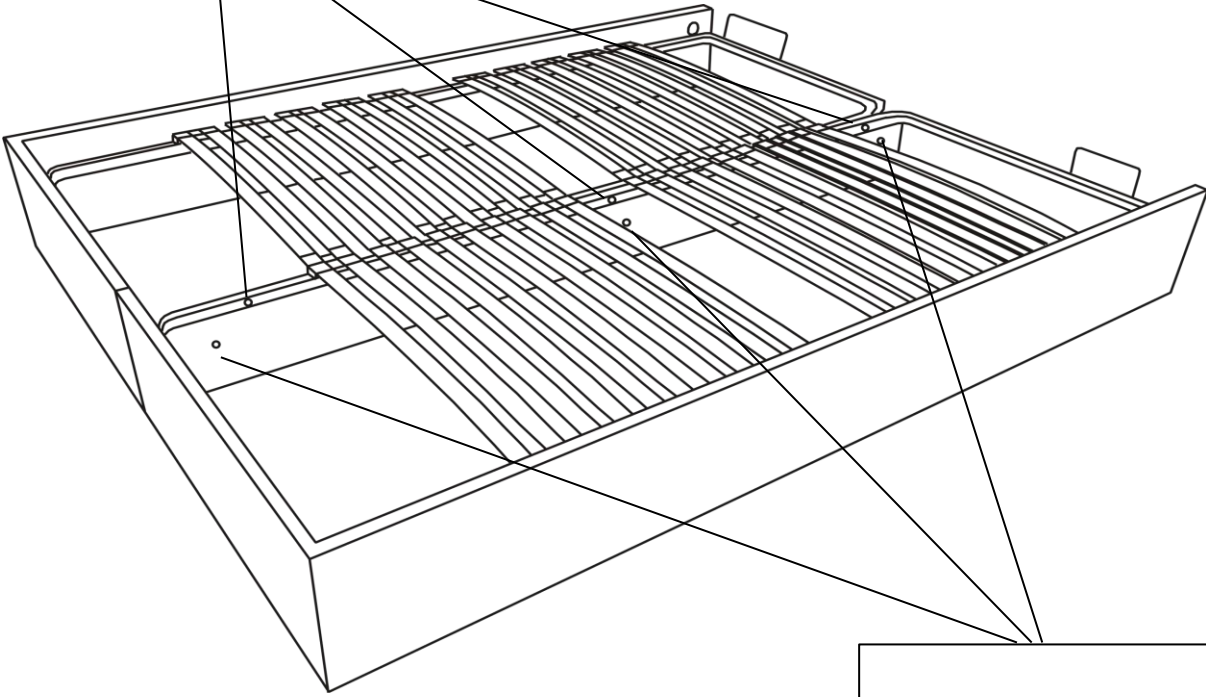

6

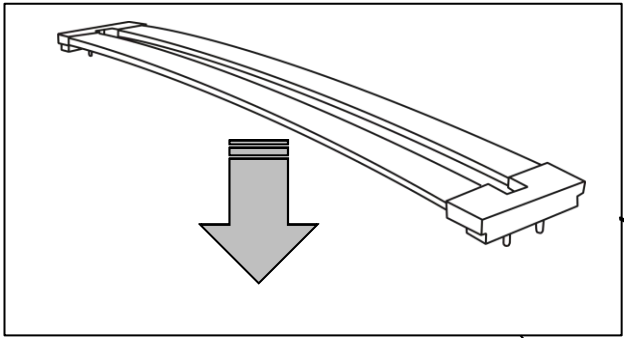

7

