

SZNB02

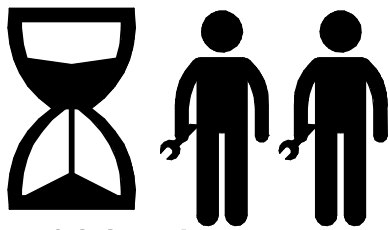

~100 min

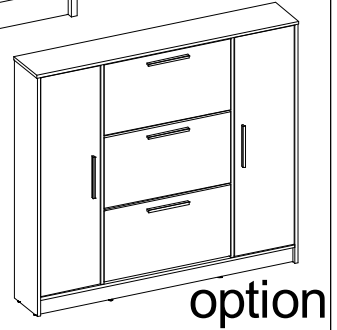
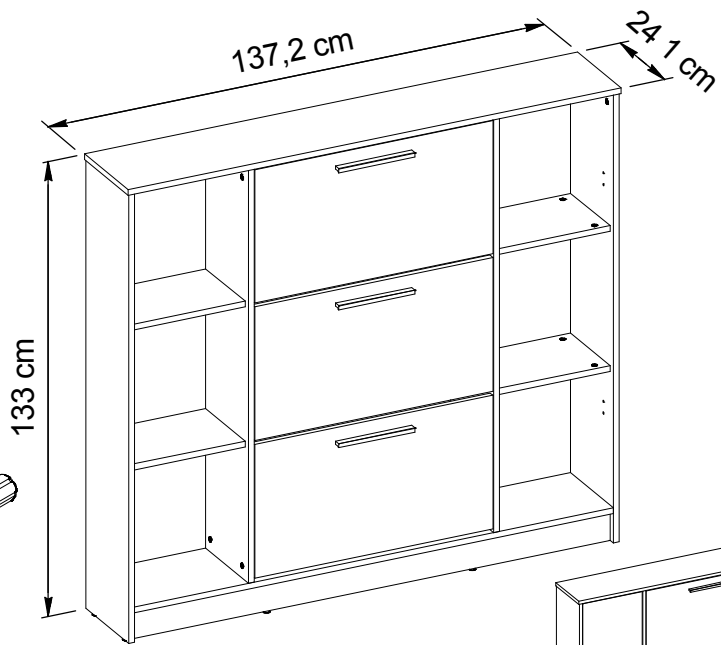
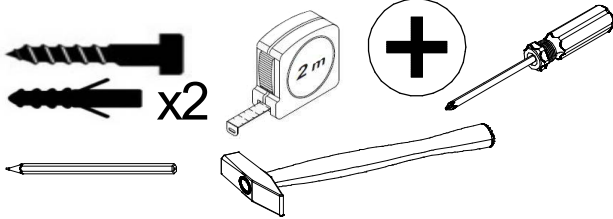

option

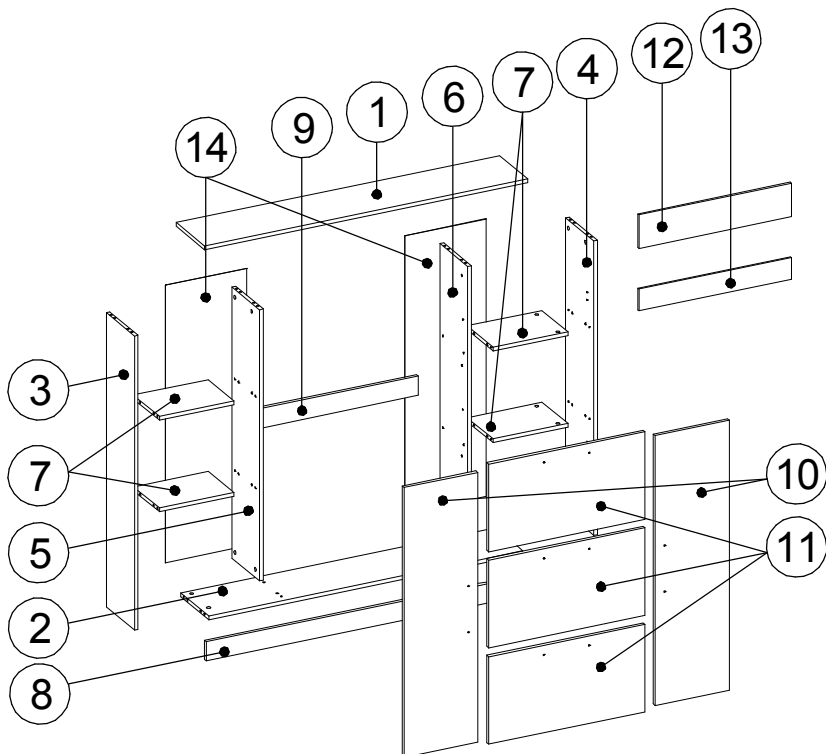
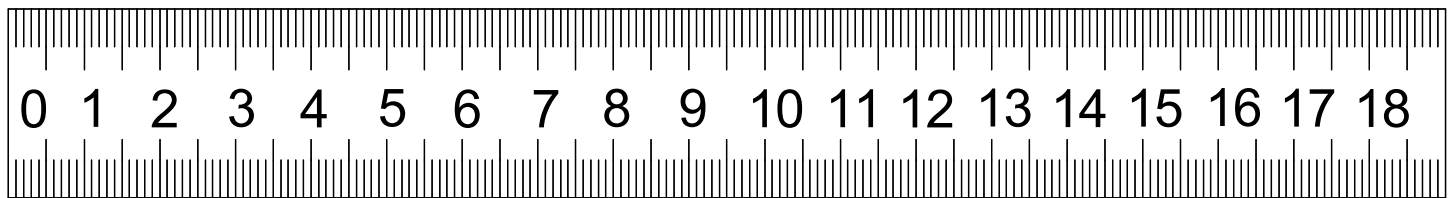
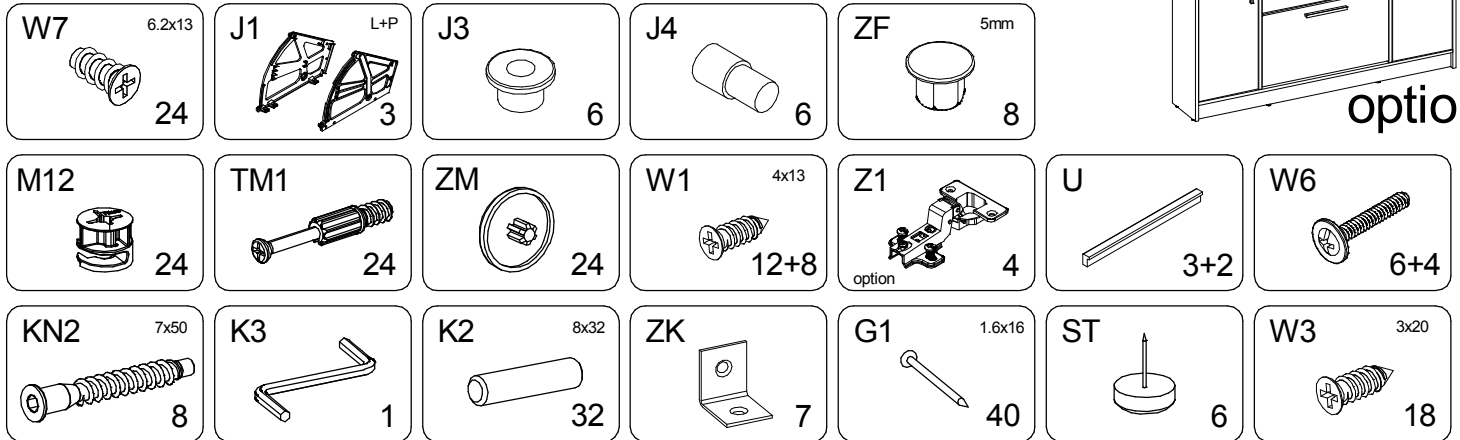

SZNB02

1	1372x241x16mm	1
2	1333x237x16mm	1
3	1226x238x16mm	1
4	1226x238x16mm	1
5	1130x236x16mm	1
6	1130x236x16mm	1
7	317x219x16mm	4
8	1333x80x16mm	1
9	667x80x16mm	1
10	1123x311x16mm	2
11	658x365x16mm	3
12	647x140x10mm	6
13	647x90x10mm	3
14	1155x344x3mm	2

▶ 1

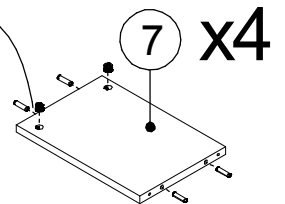
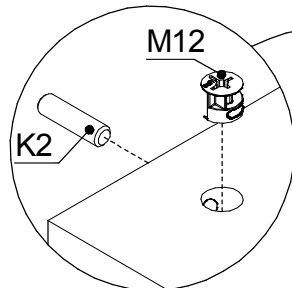
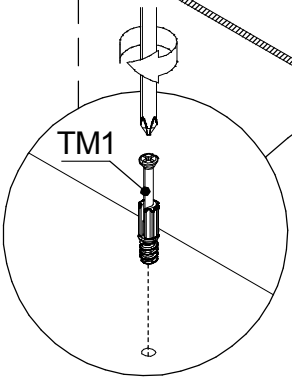
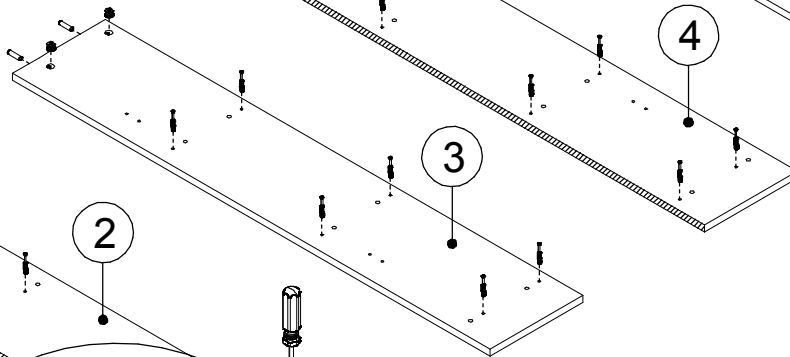
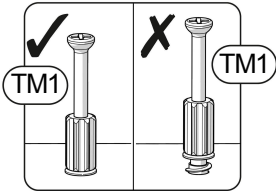
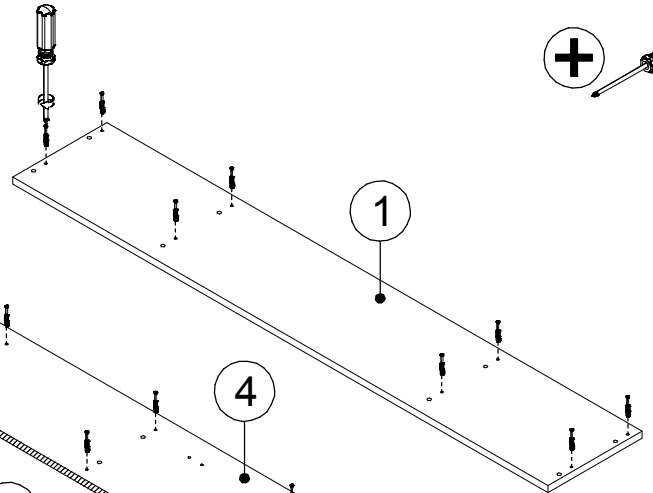
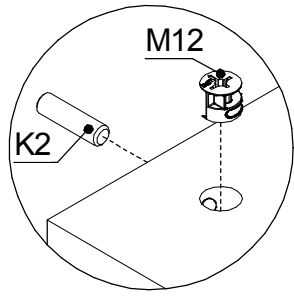
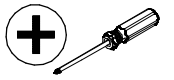
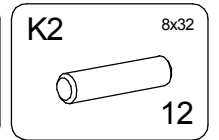
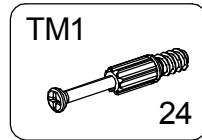
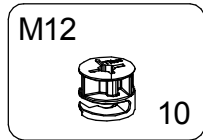
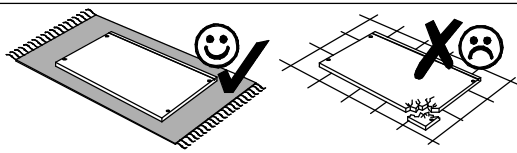

▶ 2

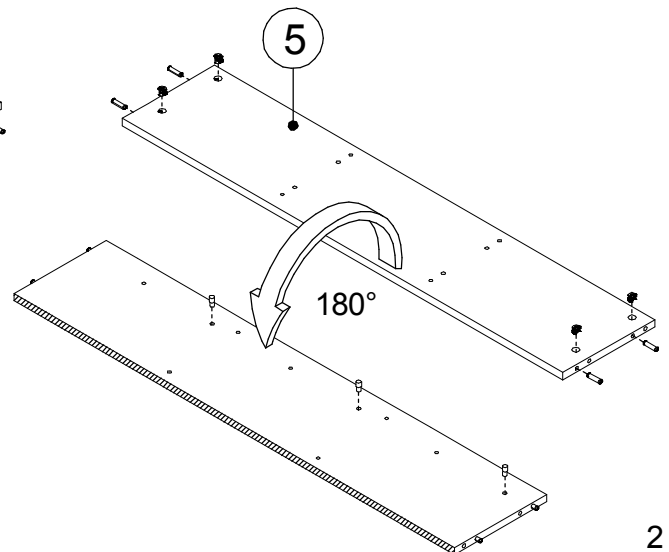
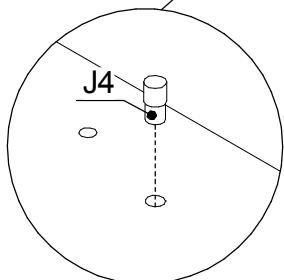
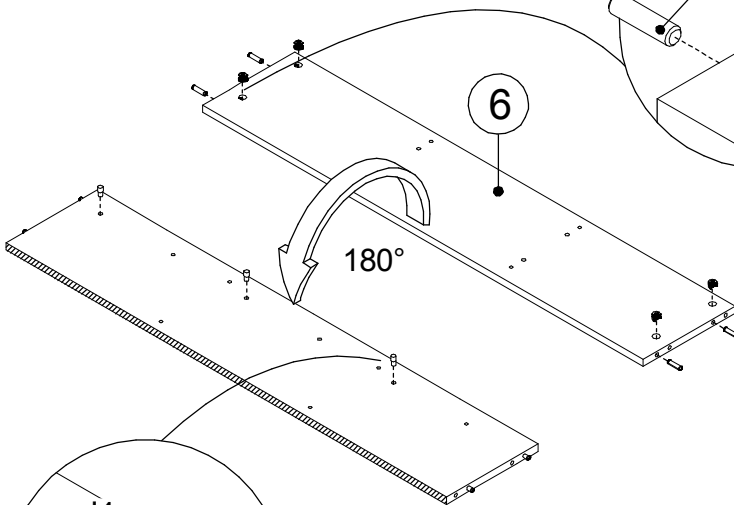
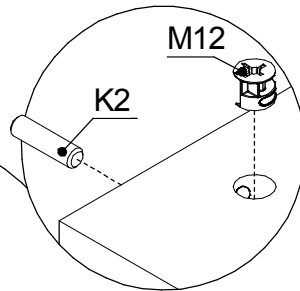
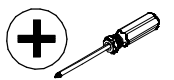
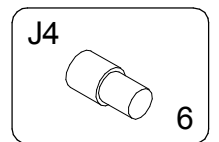
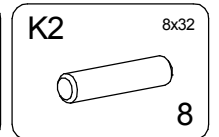
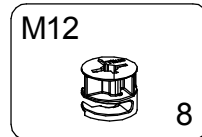
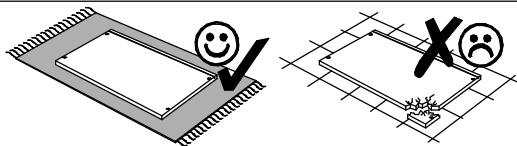

▶ 3

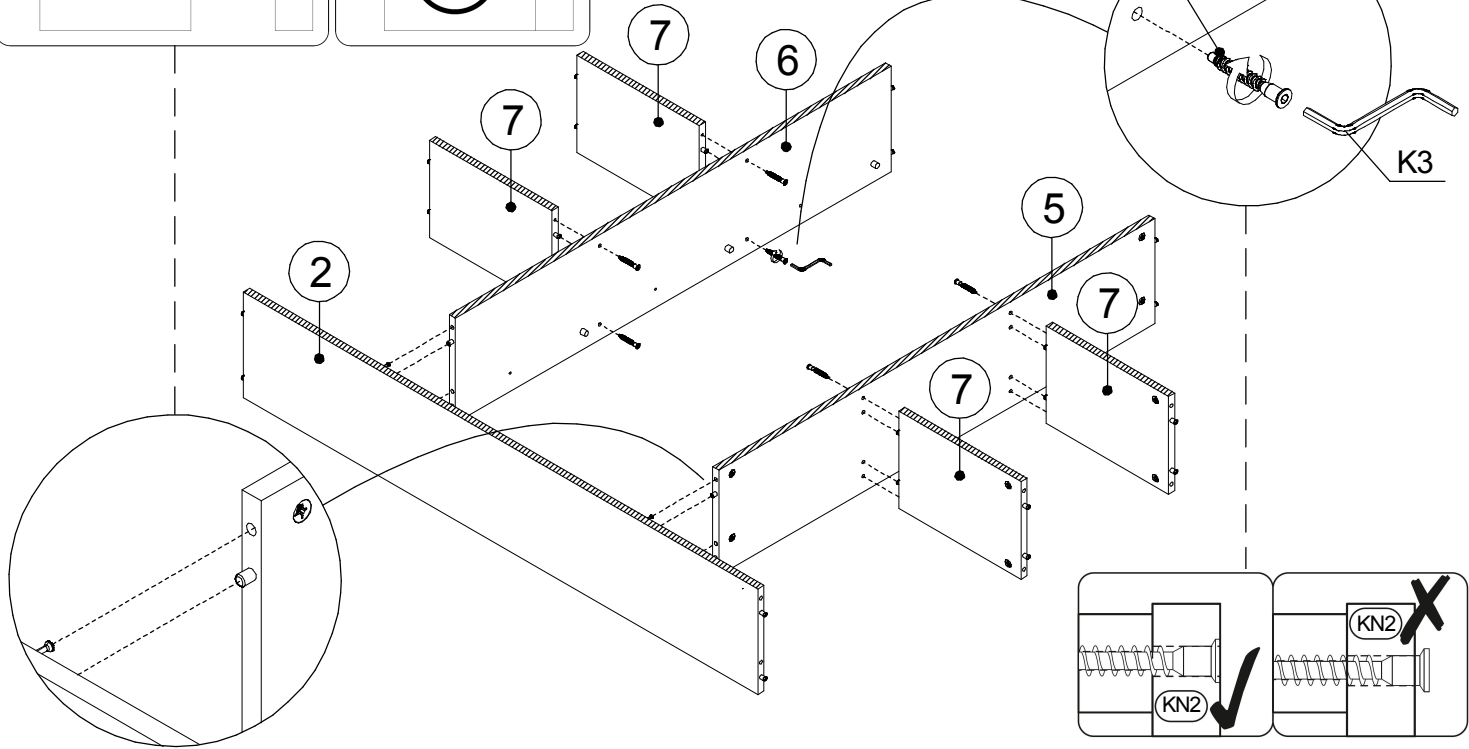
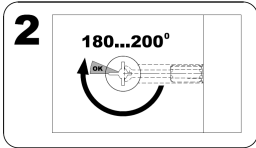
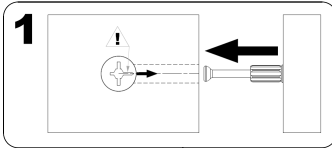
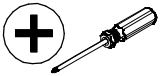
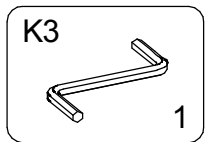
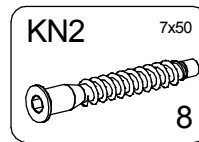
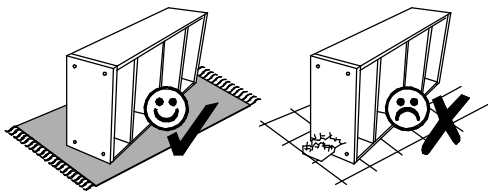

▶ 4

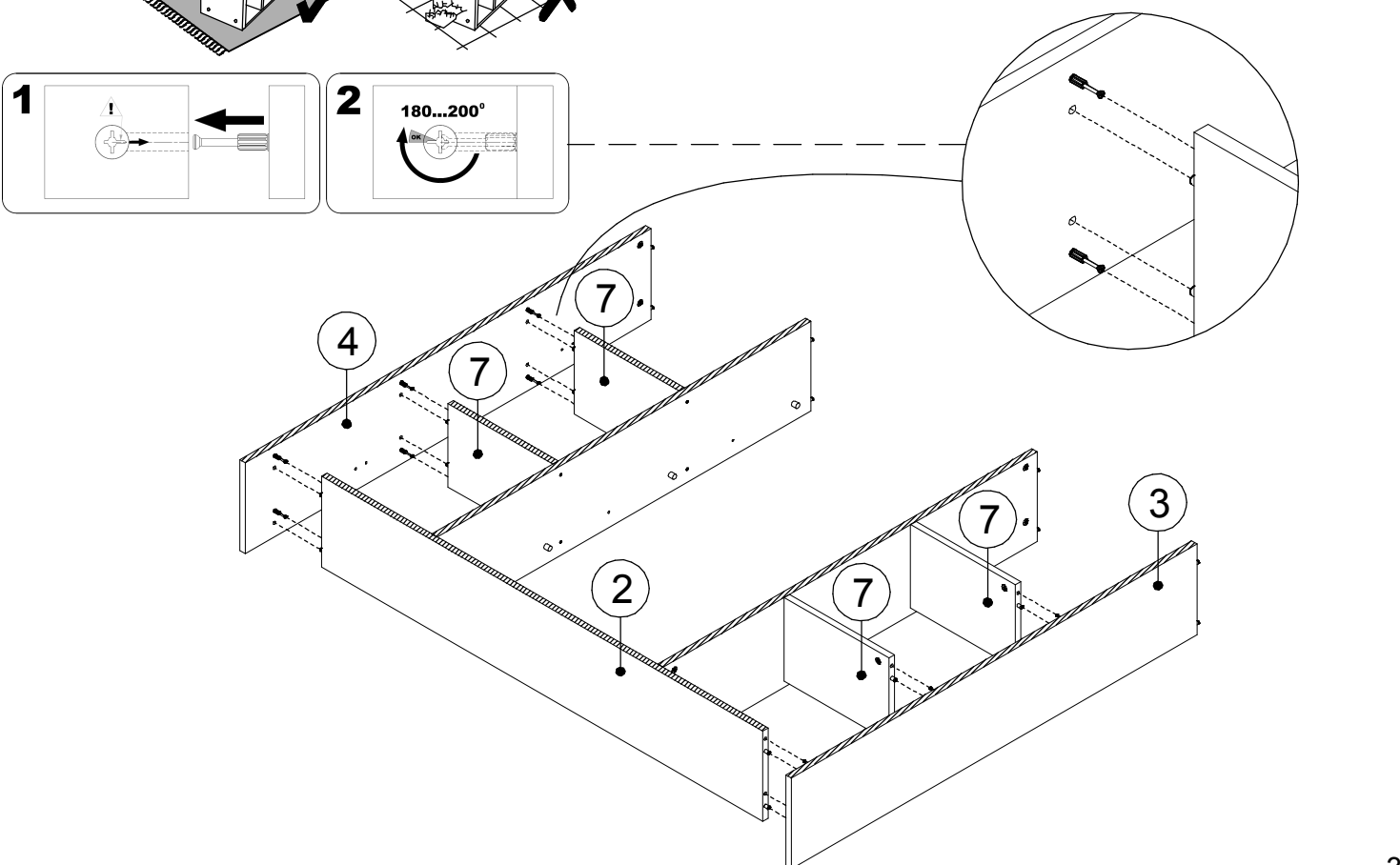
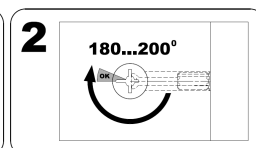
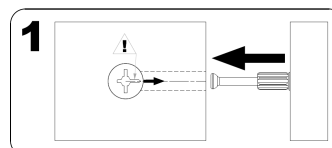
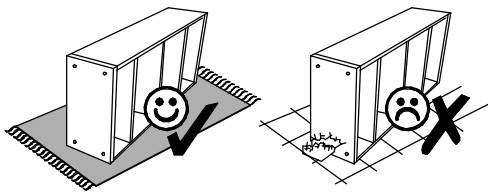

► 5

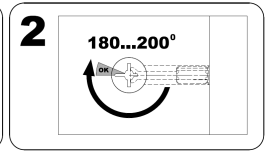
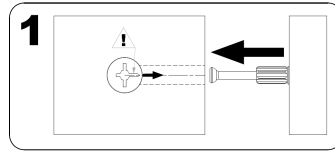
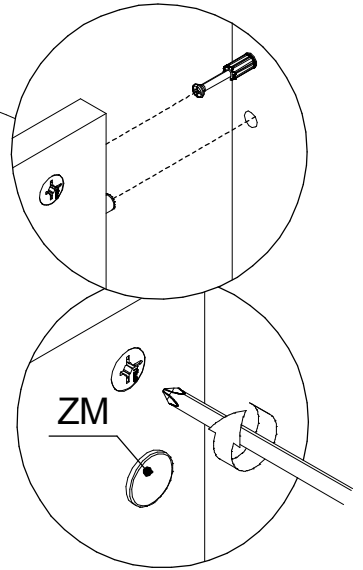
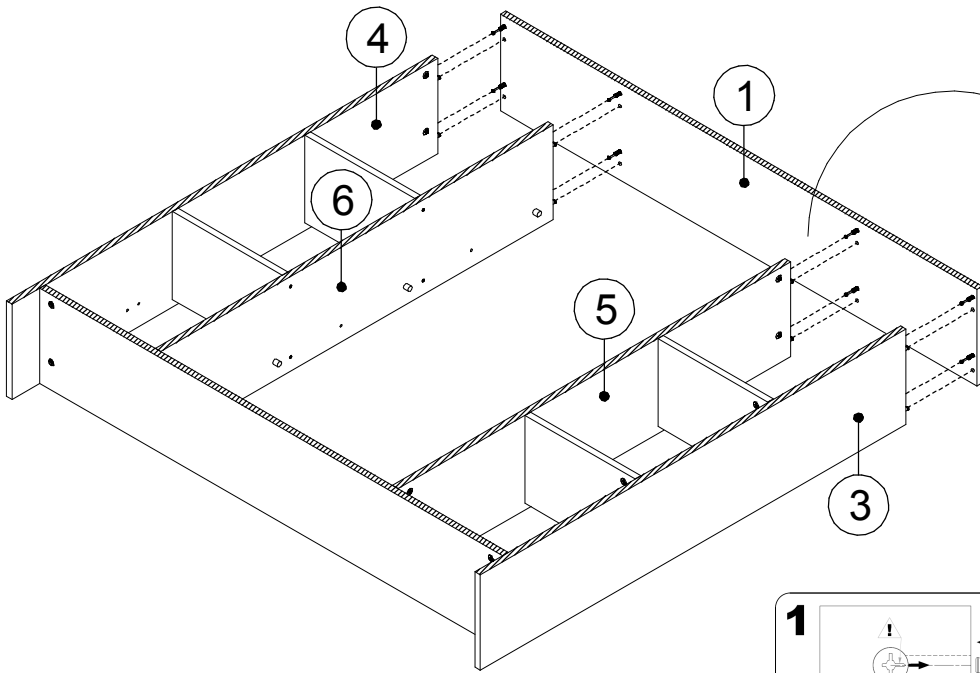
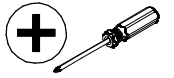
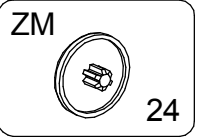
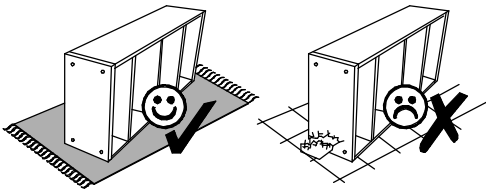

► 6

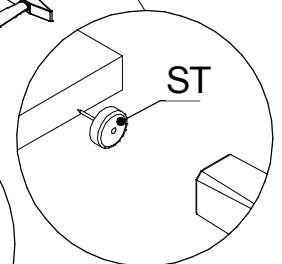
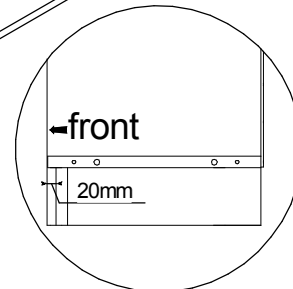
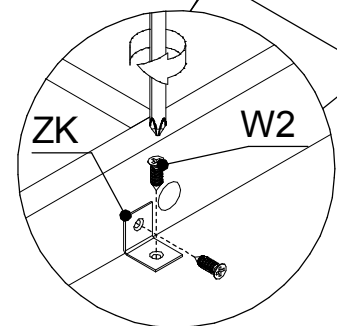
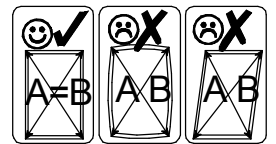
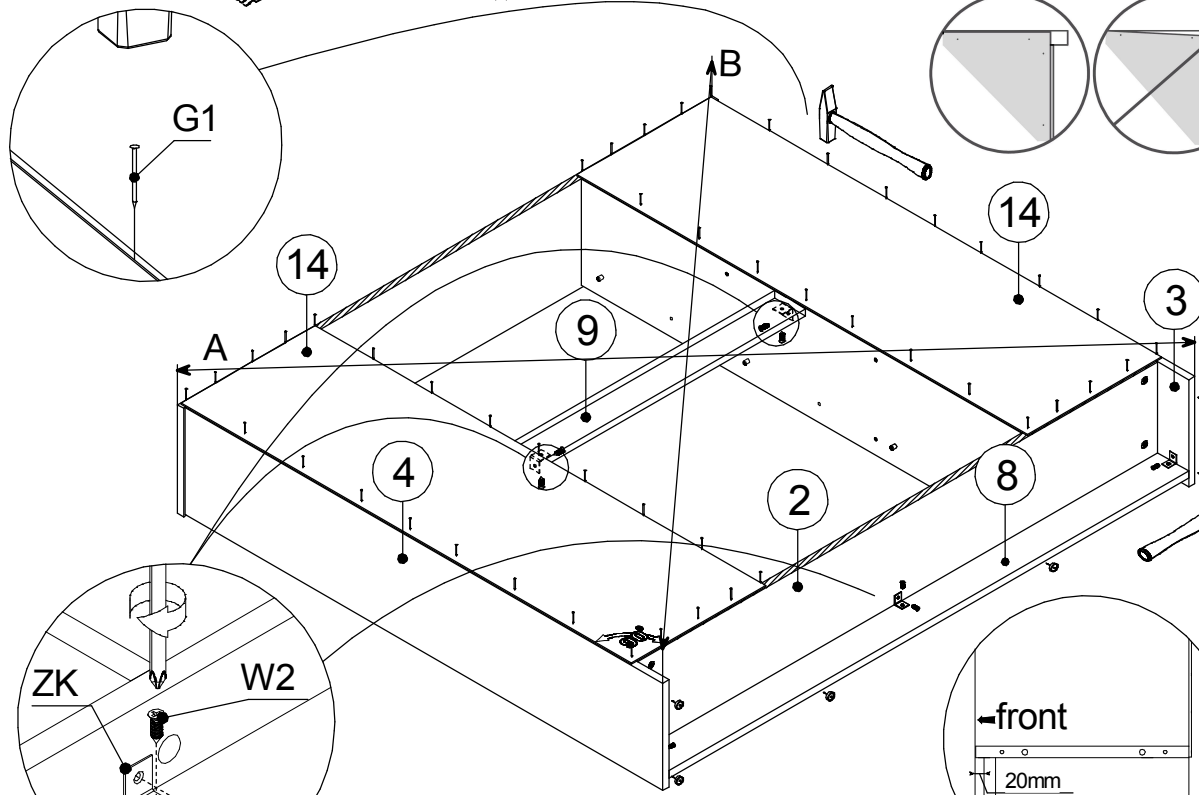
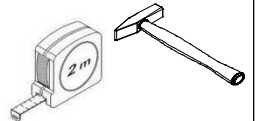
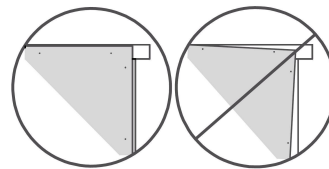
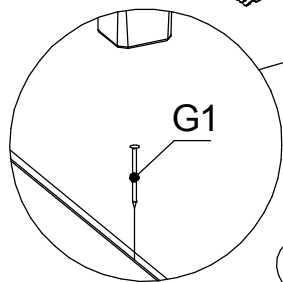
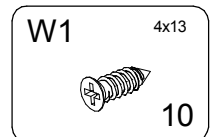
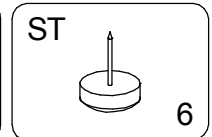
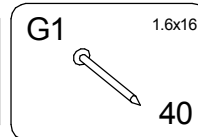
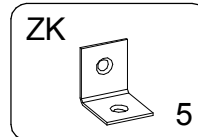
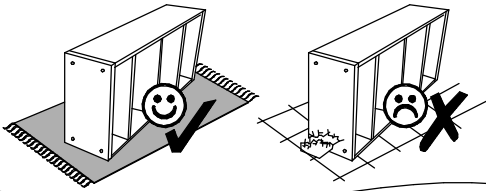

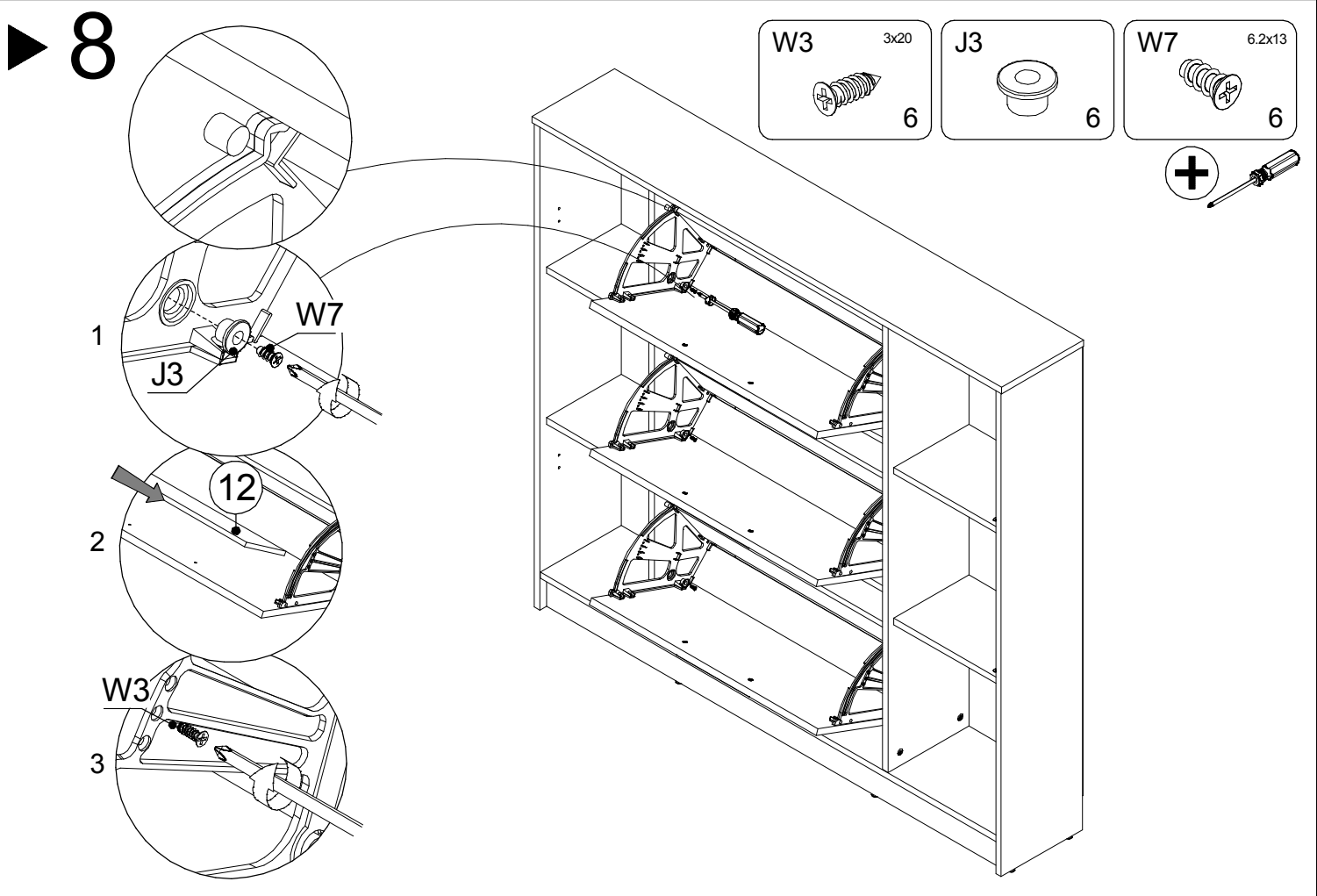
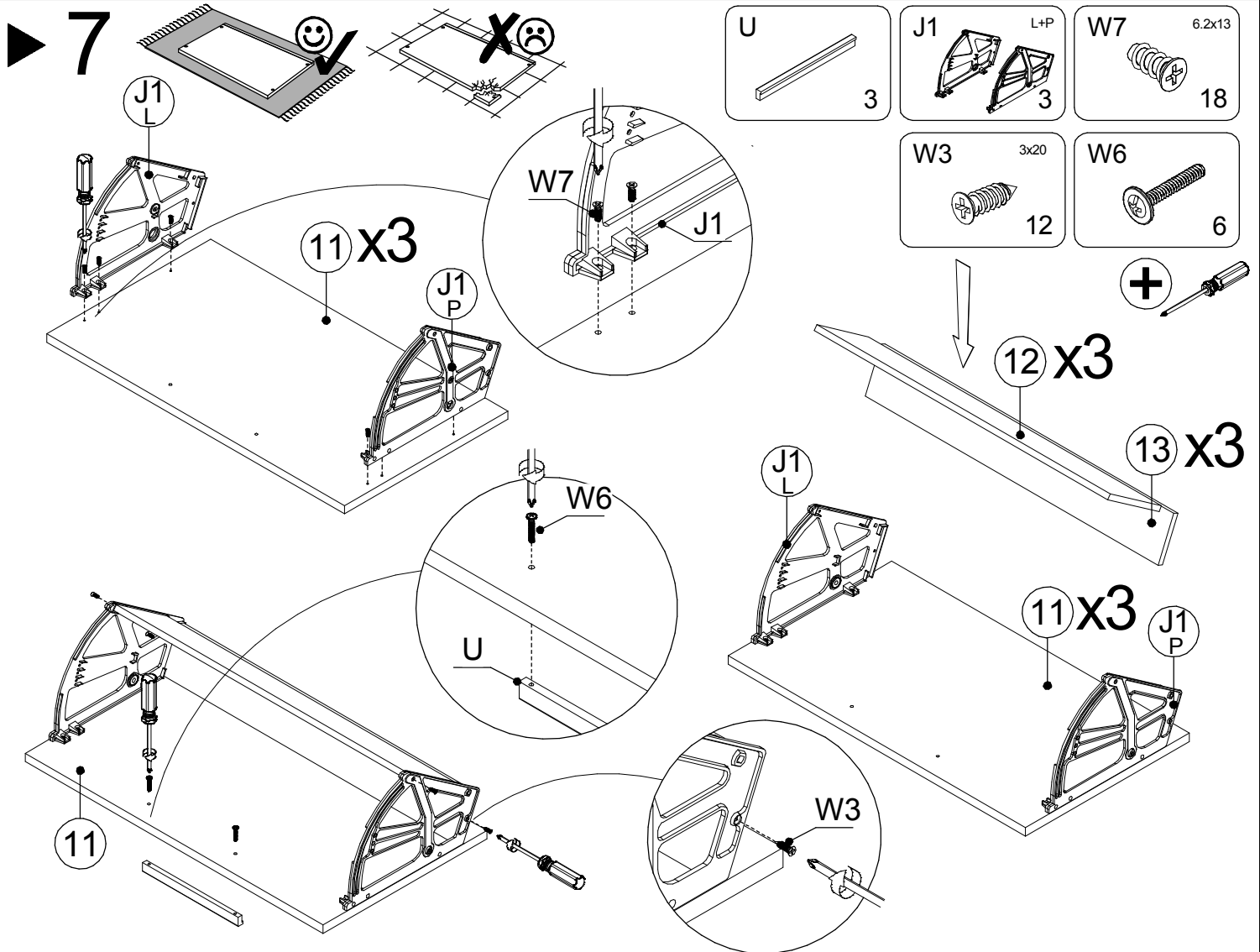

9

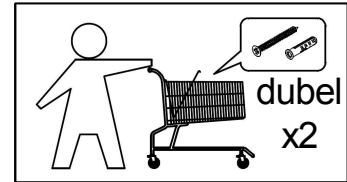
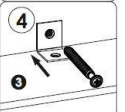
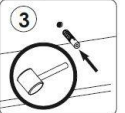
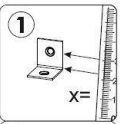
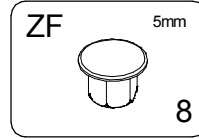
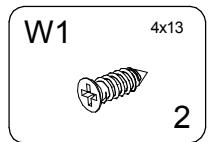
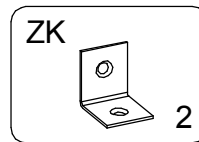
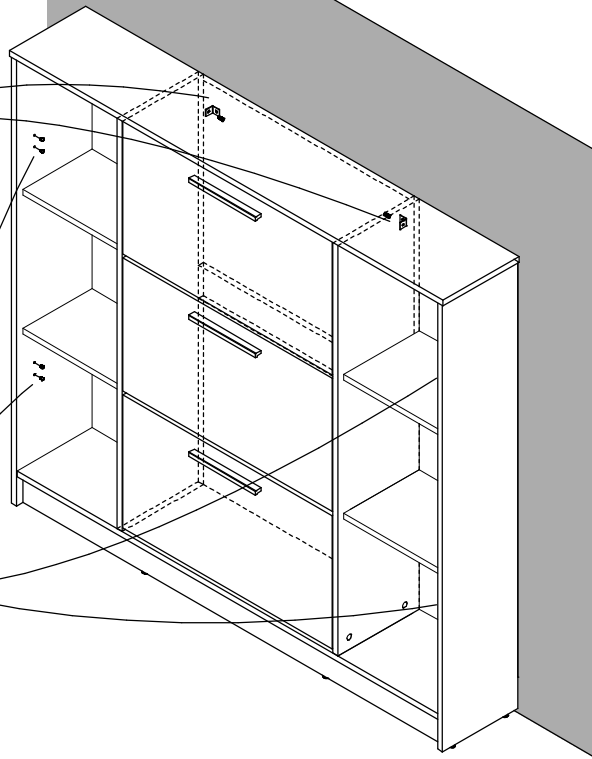
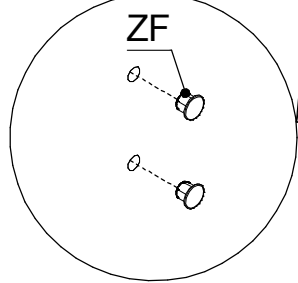
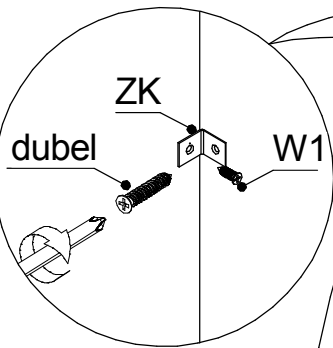

10

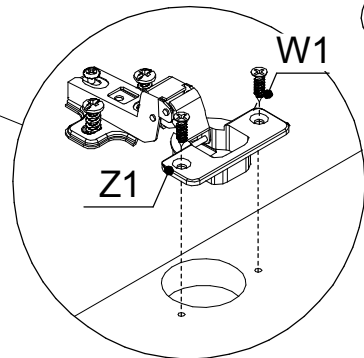
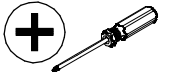
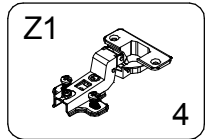
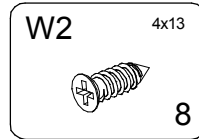
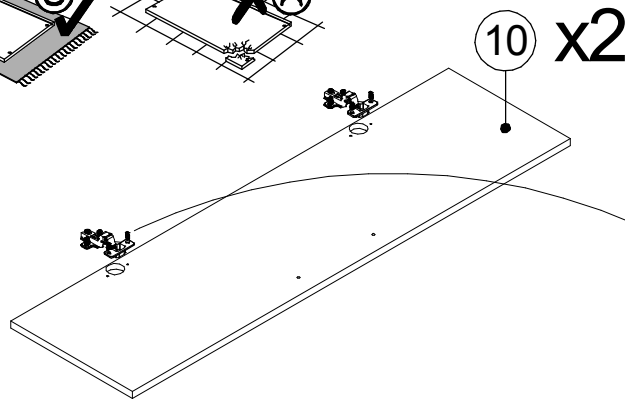
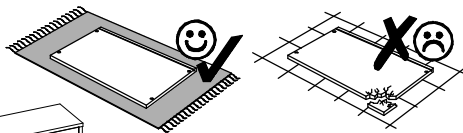

11

