

LORD LSBK160

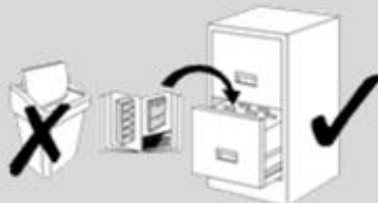

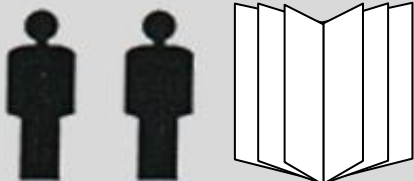

1

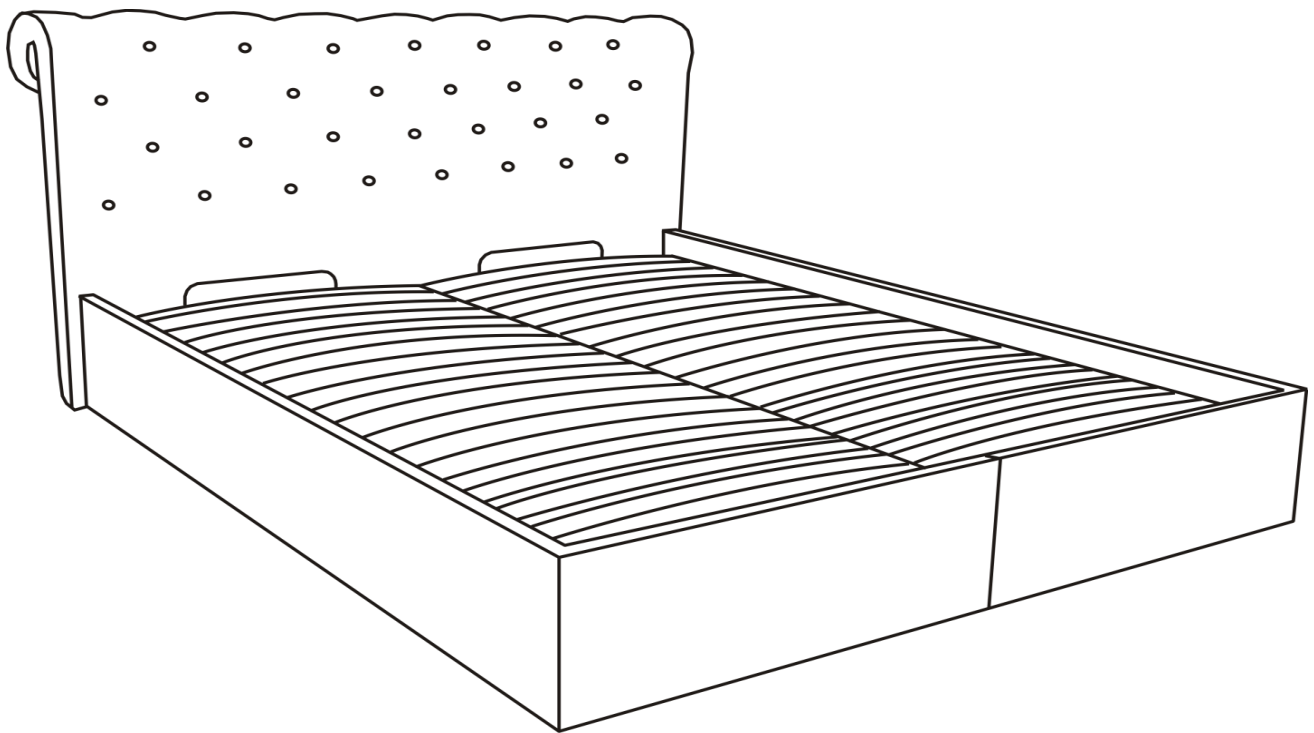
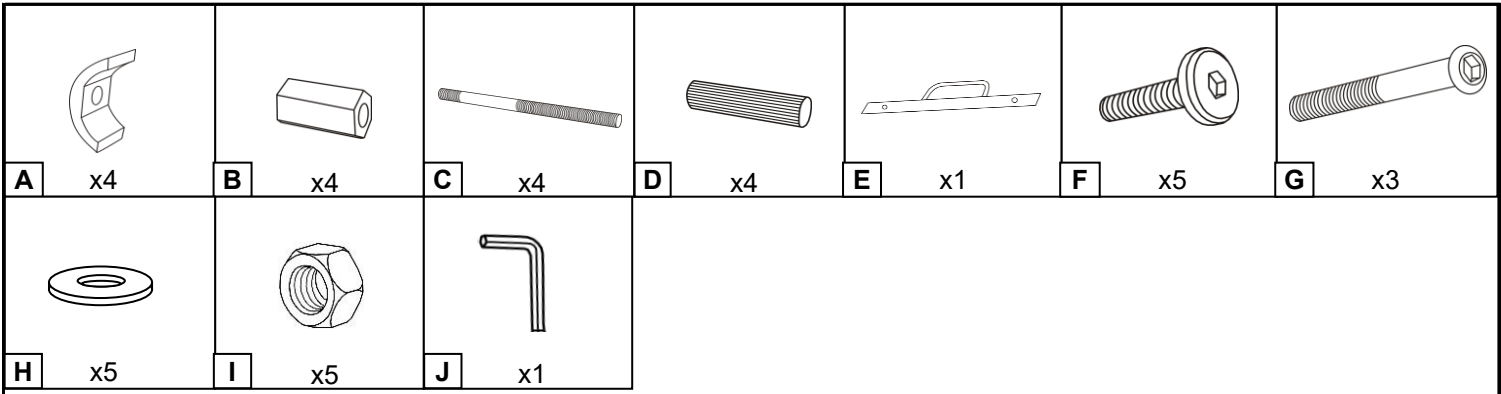
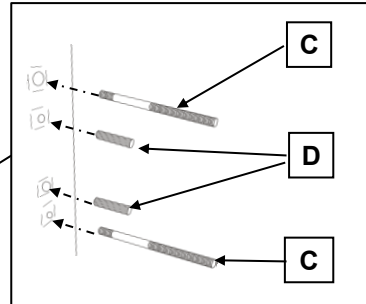
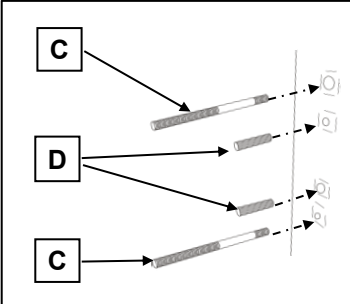
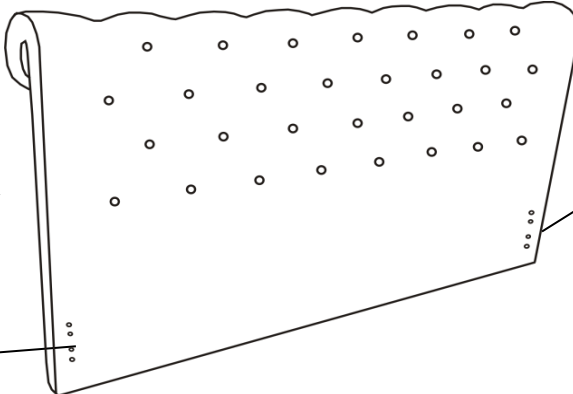

2

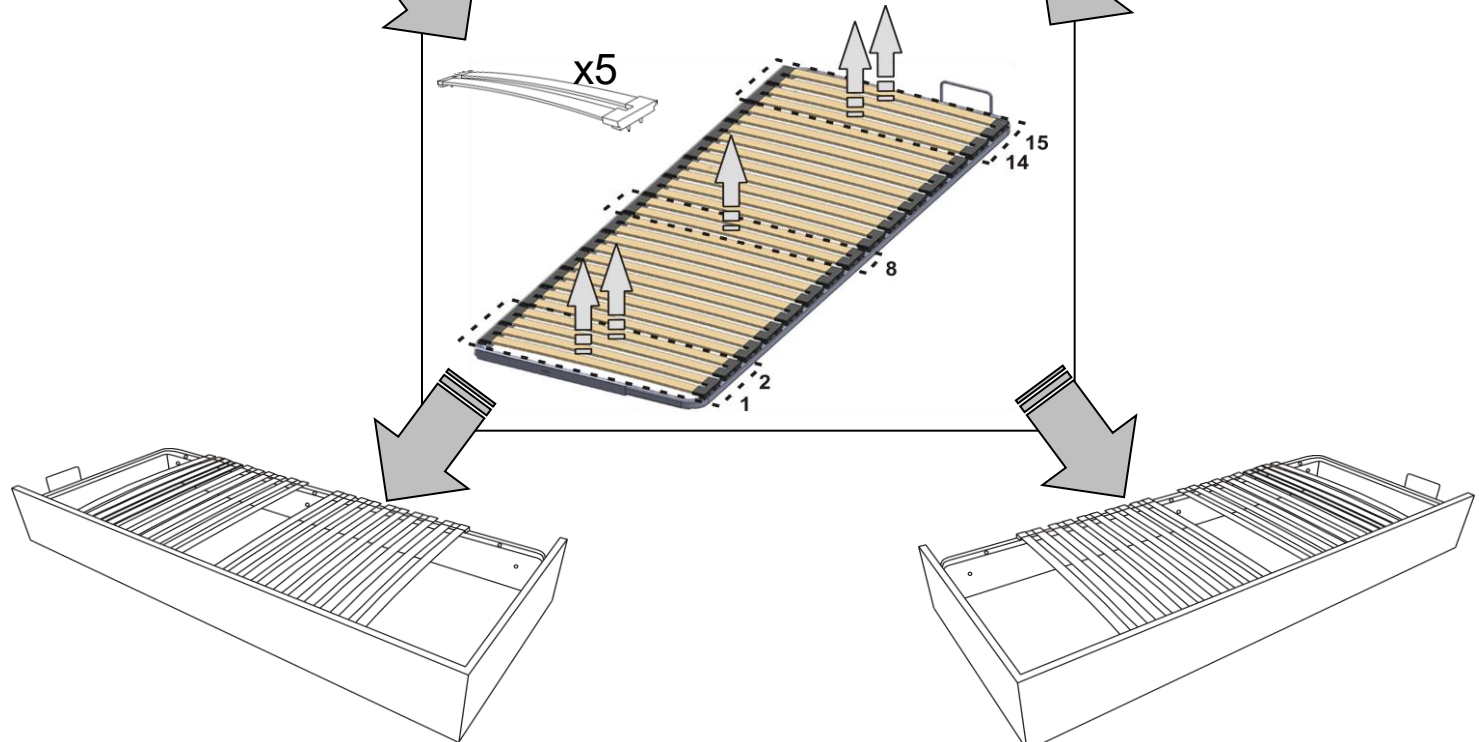
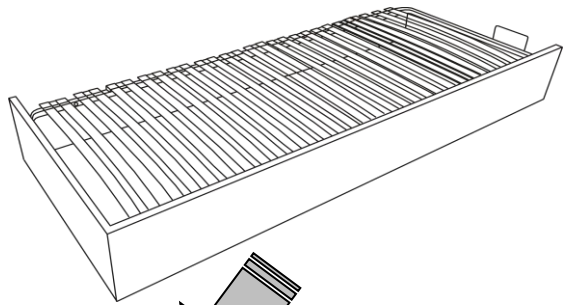
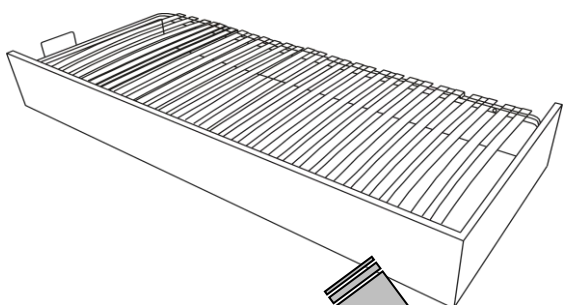

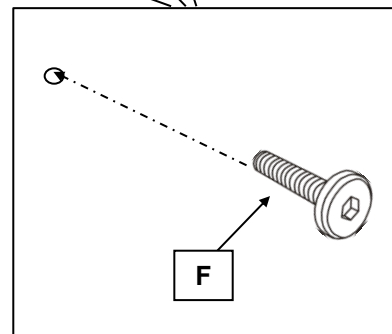
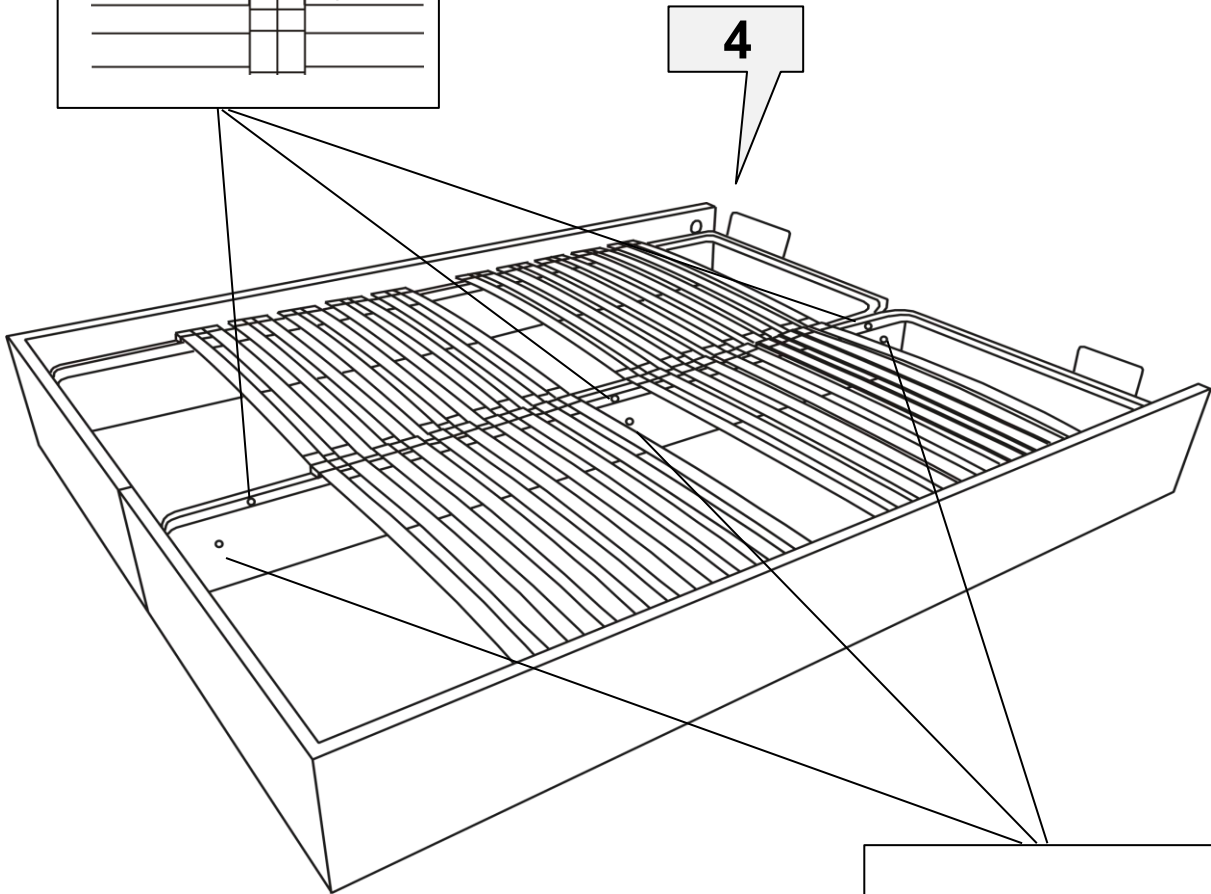
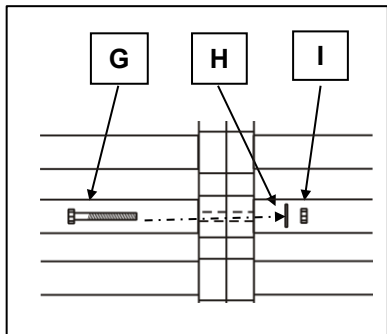
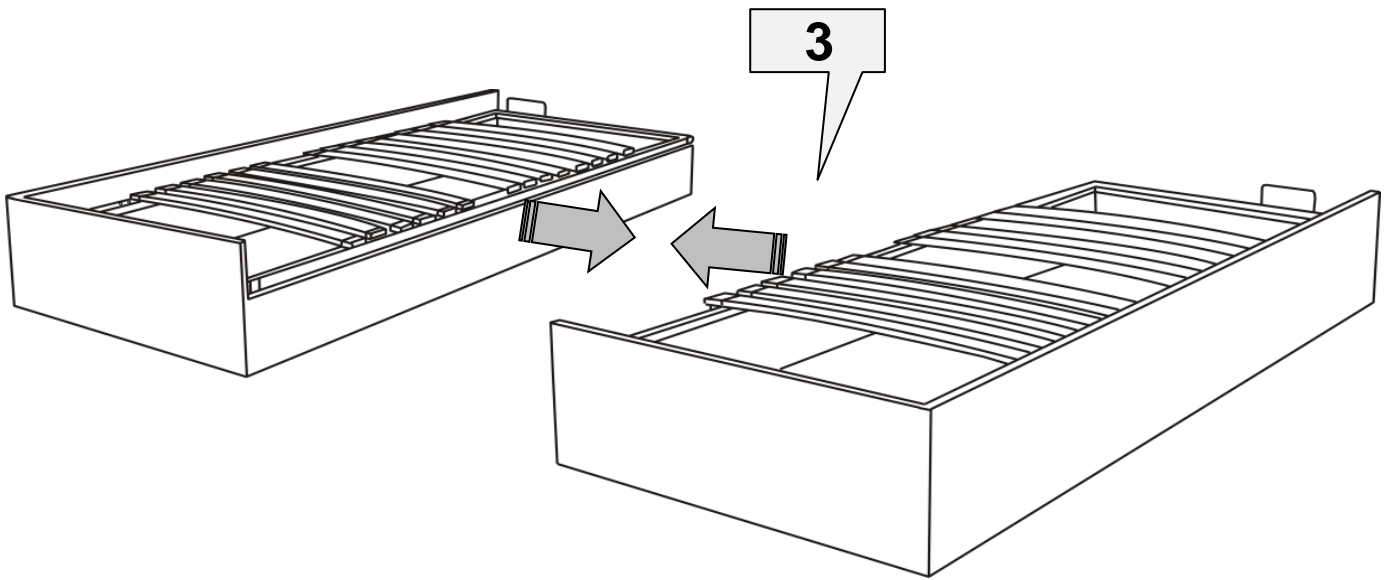

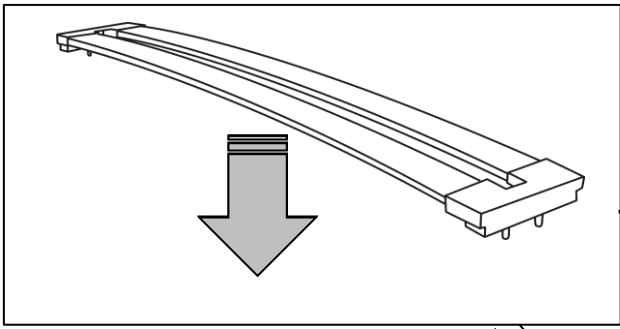

5

6

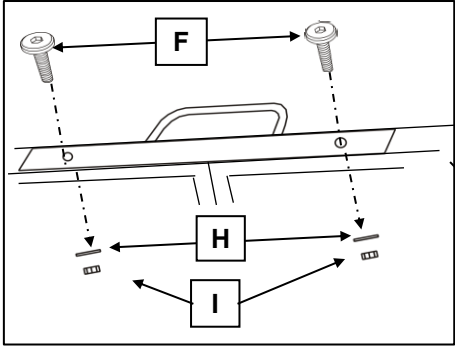

7

E

