

# SALSA.trend HOBKL-EBKL-2FR

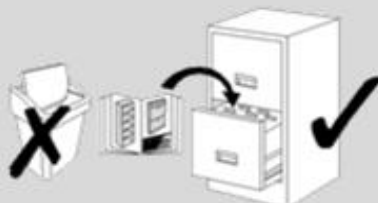

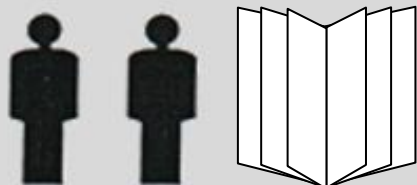

x1

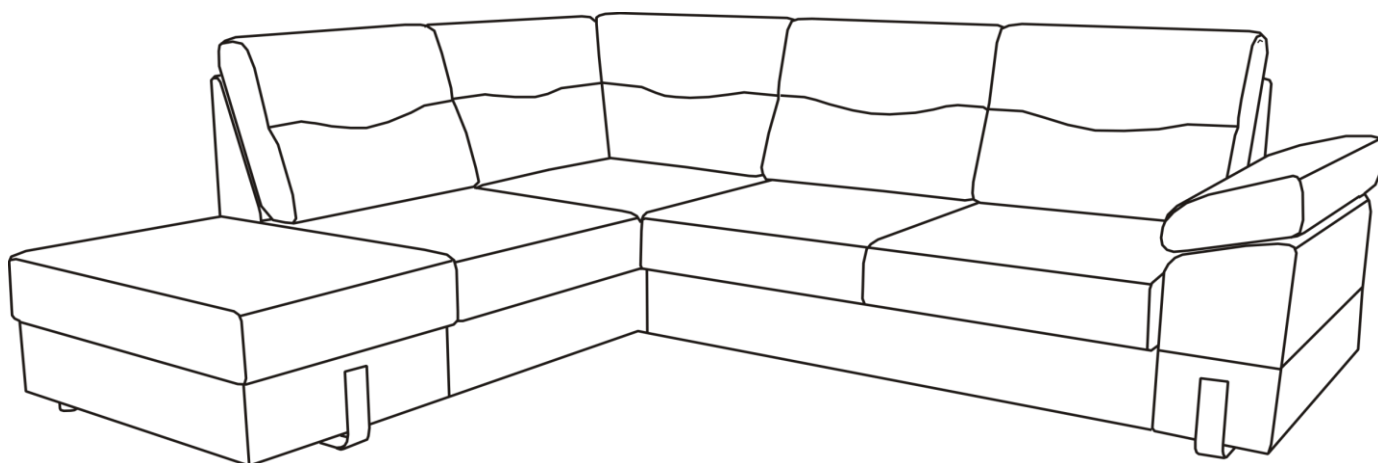
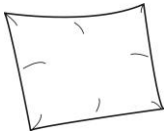
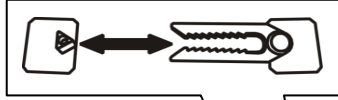

3

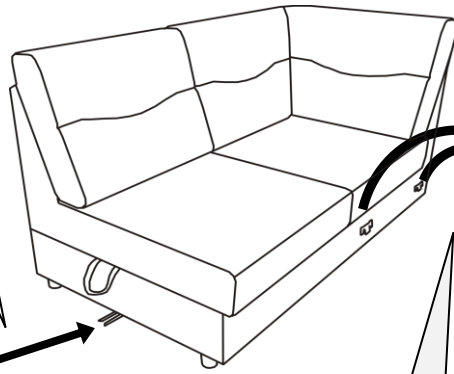
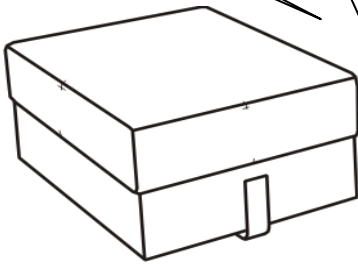

2

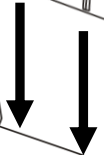
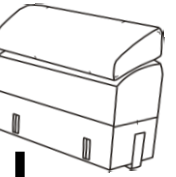
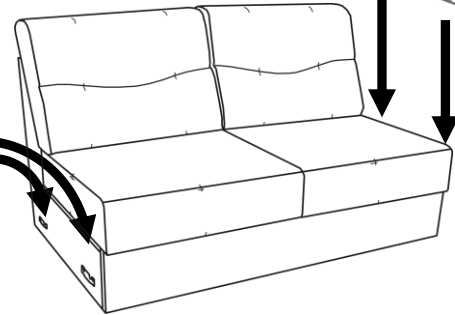

1

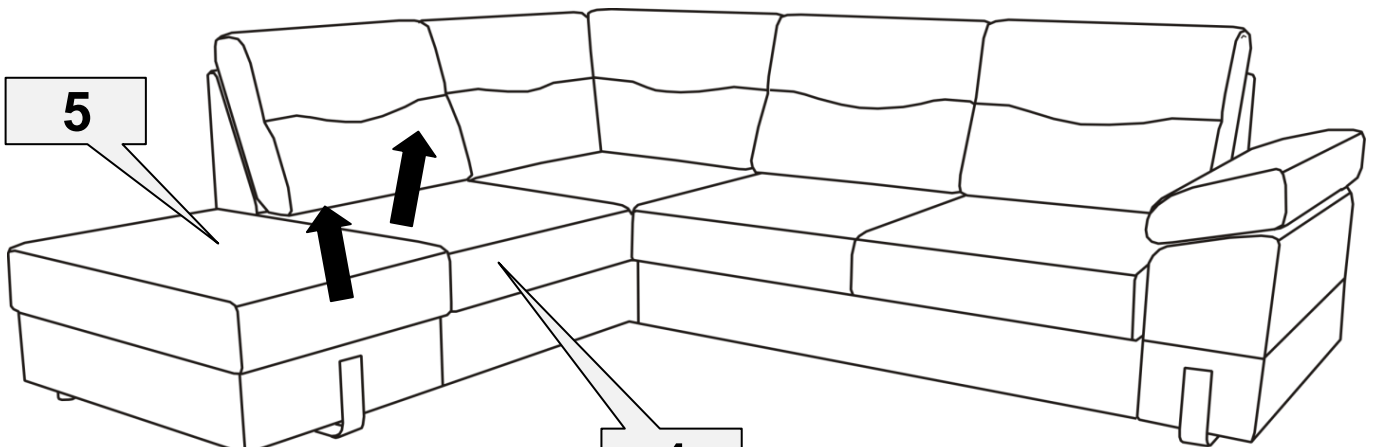

5

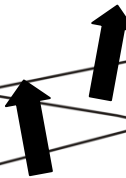

4

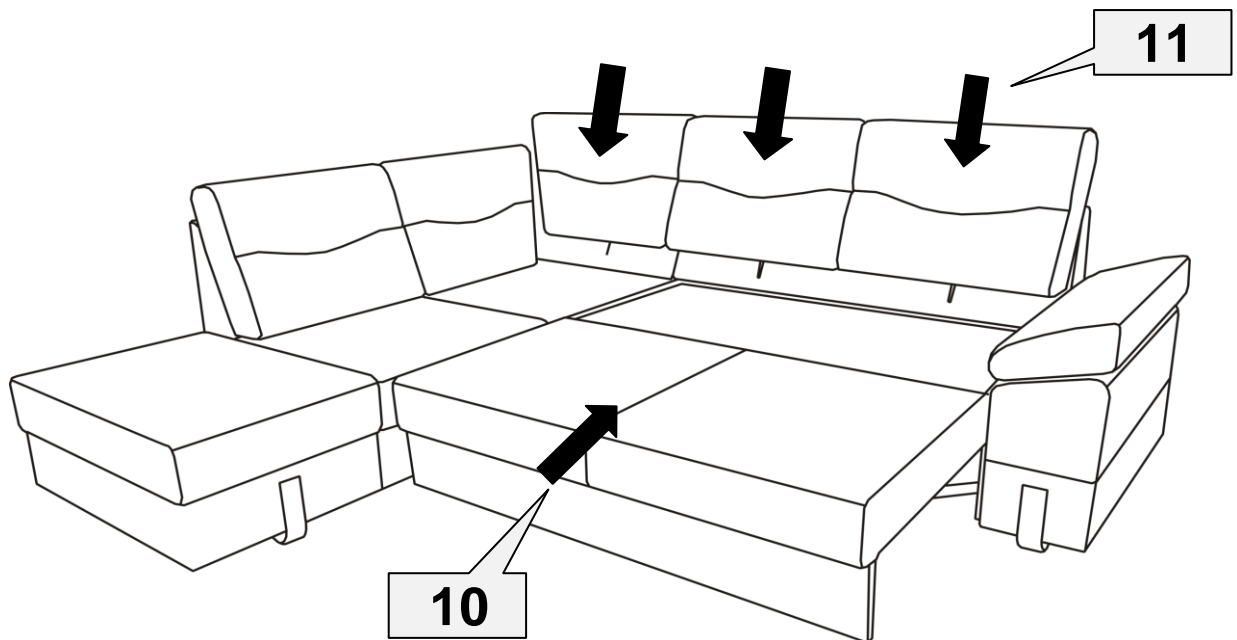
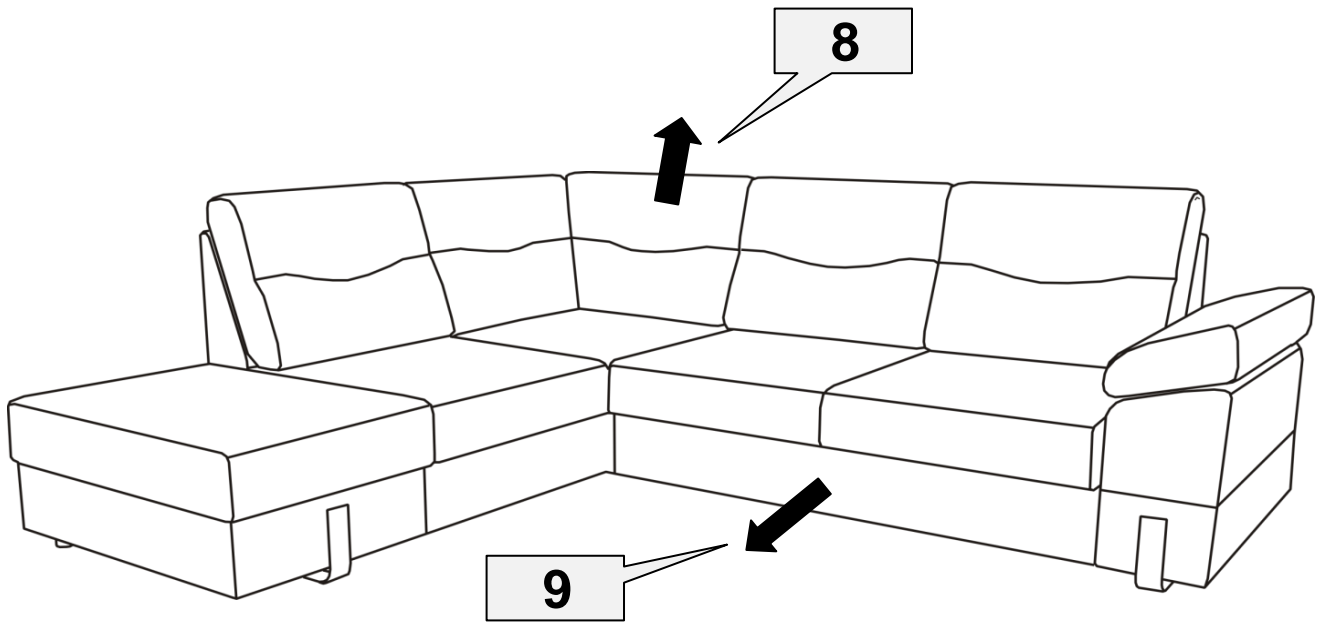
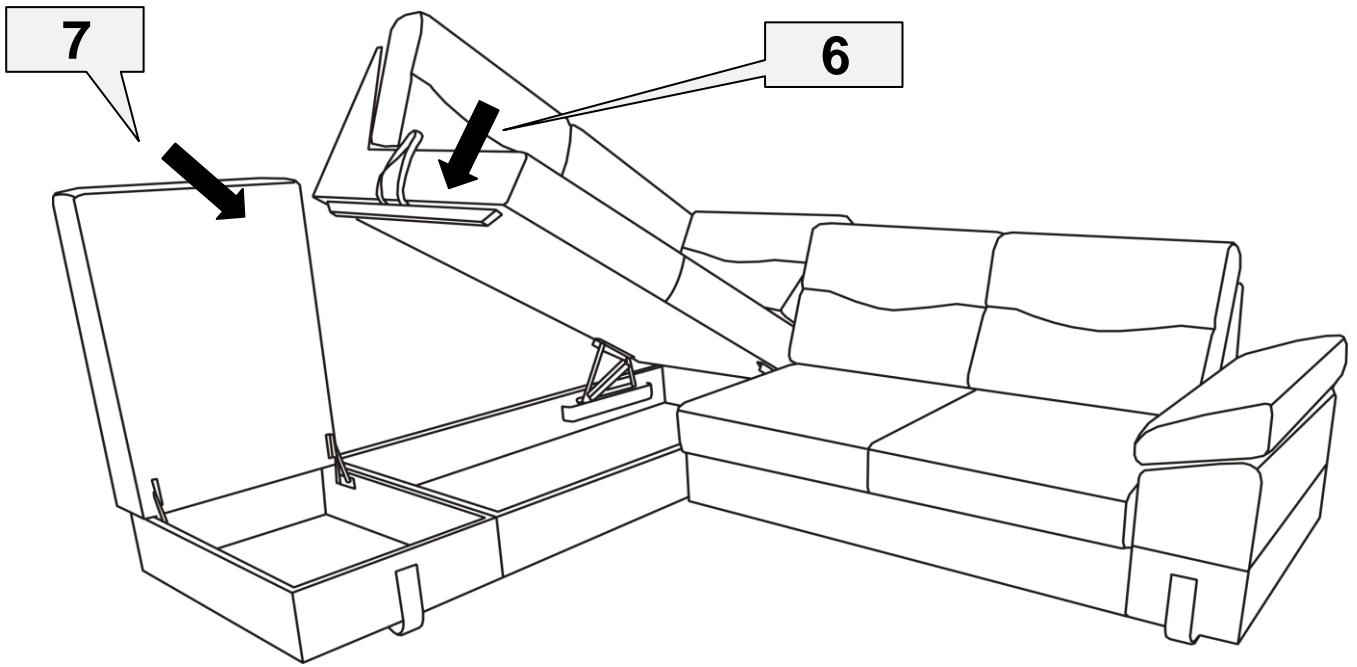

Szanowny Kliencie, po opuszczeniu poduszki narożnej należy ją ustawić, by dostosować jej grzbiet do wysokości pozostałych poduszek ruchomych.

